

Electrolux Handwashing Basins

Wall mounted or freestanding

Electrolux has designed a range of hand washbasins, with non-manual controls, constructed to comply with current hygiene standards. The range of hand washbasins consists of 4 models: one wall-mounted, knee-operated model; one free-standing, foot operated model with base cupboard; one free-standing model with two basins and one free-standing, foot-operated model with knife sterilizer.



153980

EASY TO INSTALL

- The steel foot and knee pedals make the handwashing basin extremely easy to use.
- Mixer spout, 1/2" in diameter and drain hole supplied as standard.

EASY TO USE

- Constructed entirely in 18/10 stainless steel.
- Sound deadened pressed bowl with rounded corners and all-round lip to prevent overspill.
- The model with knife sterilizer has two basins, a thermometer to ensure that the water is at the correct temperature for sterilizing the knives and a thermostat.

- Model HWSD5 has an upper hand washbasin (dimensions 300x240x150) and a lower drainage sink with a steel support grid.
- Rear upstand with 8 mm rounded corner, 100 mm in height and 13 mm deep.
- Free-standing models are equipped with stainless steel foot pedals and side-hinged door (except for model HWSD5).
- Feet with round section (diameter 50 mm) except for the model HWSD5 that has square section (40x40mm) and hinged door for the freestanding version.

EASY TO CLEAN

- Easy cleaning thanks to the rounded bowl and corners.
- All models comply with the more strict international standards as far as hygiene and cleanability are concerned.

ACCESSORIES

- The washbasins can be equipped with a wall panel and paper and soap dispensers as optional extras.



Electrolux

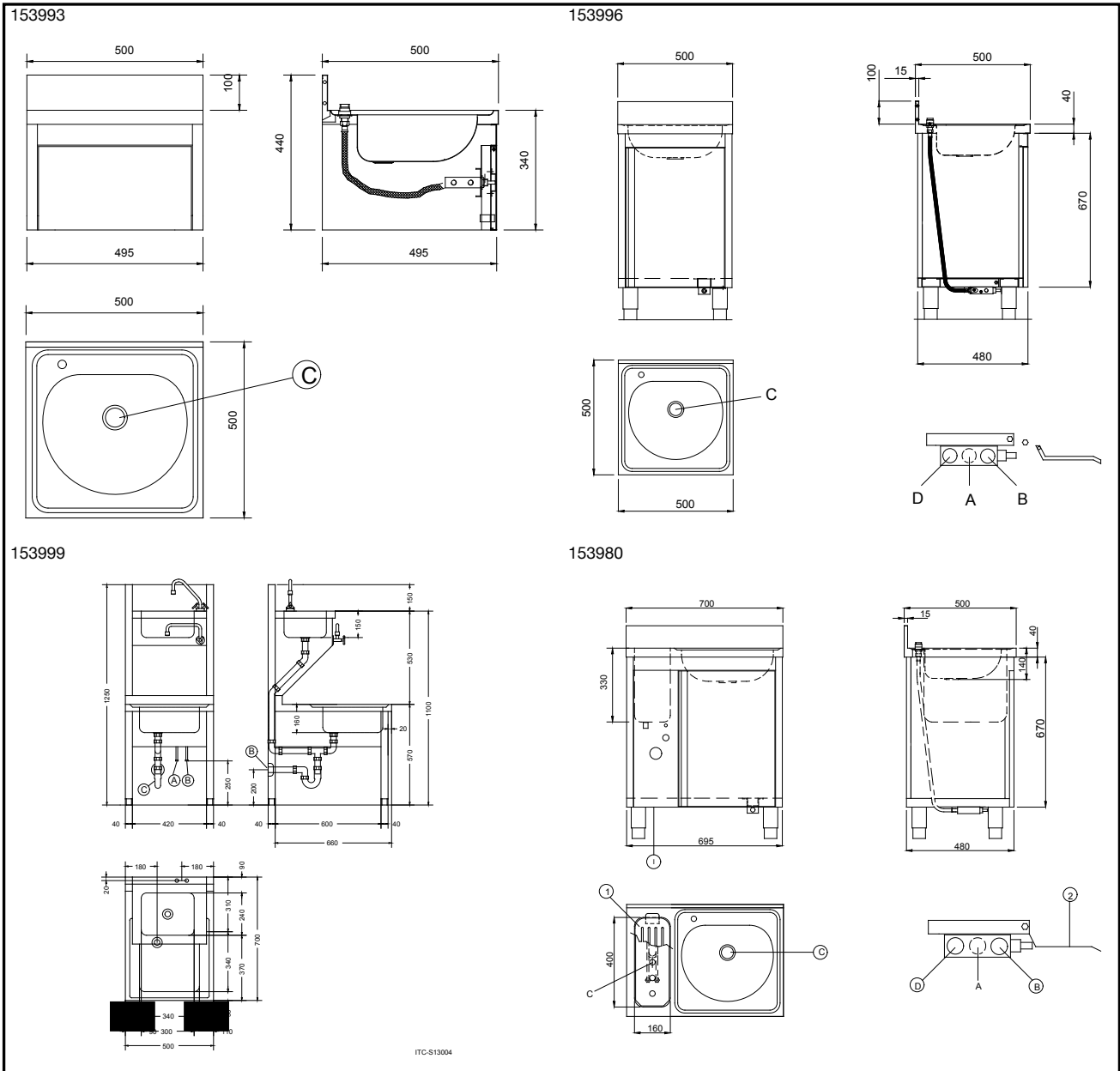

Electrolux Handwashing Basins

Wall mounted or freestanding

AF00010

2008-05-30

Subject to change without notice

	HWSW5 153993	HWSF5 153996	HWSD5 153999	HWSS7 153980
LEGEND				
A - Hot water inlet	1/2"	1/2"	1/2"	1/2"
B - Cold water inlet	1/2"	1/2"	1/2"	1/2"
C - Water drain	1"1/2	1"1/2	1"1/2	1"1/2
I - Electrical connection				220...240 V, 1N, 50/60
TECHNICAL DATA				
External dimensions - mm				
width	500	500	500	700
depth	500	500	700	500
height	340	850	1250	850
Worktop thickness - mm				
Worktop	50	50	50	50
Upstand dimensions - mm				
height	100	100		100
depth	13	13		13
Bowls - n.				
Bowl dimensions (wxdxh) - mm	340x370xH160	340x370xH160	340x340xH160	340x340xH160
Power - kW				
installed-electric				1.5
Net weight - kg.	12	40	50	12
Supply voltage				220...240 V, 1N, 50/60
ACCESSORIES				
DRAIN/CUT-OFF VALVE AND SYPHON KIT				850410
FITTING WALL FOR HAND WASH BASIN	850400	850400		
FITTING WALL FOR HAND WASH BASIN				850403
SINGLE BRASS DRAIN SYPHON 1,5"	855308	855308	855308	855308
SINGLE PLASTIC DRAIN SYPHON 1,5"	855306	855306	855306	
SOAP DISPENSER FOR HAND WASH BASIN	850401	850401		850401
TOWEL DISPENSER FOR HAND WASH BASIN	850402	850402		850402